

Power MOSFET N-Channel/P-Channel SC-88

- We declare that the material of product are Halogen Free and compliance with RoHS requirements.
- S- Prefix for Automotive and Other Applications Requiring Unique Site and Control Change Requirements; AEC-Q101 Qualified and PPAP Capable.

MAXIMUM RATINGS (T_J = 25°C unless otherwise noted)

Rating	Symbol	Value	Unit
Drain-to-Source Voltage	V _{DSS}	50	V _{dc}
Gate-to-Source Voltage – Continuous	V _{GS}	± 20	V _{dc}
Drain Current			mA
– Continuous @ T _A = 25°C	I _D	130	
– Pulsed Drain Current (t _p ≤ 10 μs)	I _{DM}	520	
Total Power Dissipation @ T _A = 25°C	P _D	380	mW
Operating and Storage Temperature Range	T _J , T _{stg}	– 55 to 150	°C
Thermal Resistance – Junction-to-Ambient	R _{θJA}	328	°C/W
Maximum Lead Temperature for Soldering Purposes, for 10 seconds	T _L	260	°C

LBSS8402DW1T1G S-LBSS8402DW1T1G

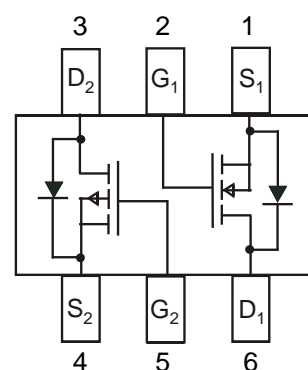
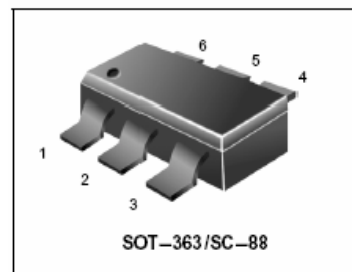

ORDERING INFORMATION

Device	Marking	Shipping
LBSS8402DW1T1G S-LBSS8402DW1T1G	402	3000 Tape & Reel
LBSS8402DW1T3G S-LBSS8402DW1T3G	402	10000 Tape & Reel

LBSS8402DW1T1G , S-LBSS8402DW1T1G
N-Channel
ELECTRICAL CHARACTERISTICS ($T_A = 25^\circ\text{C}$ unless otherwise noted)

Characteristic	Symbol	Min	Typ	Max	Unit
----------------	--------	-----	-----	-----	------

OFF CHARACTERISTICS

Drain-to-Source Breakdown Voltage ($V_{GS} = 0\text{ Vdc}$, $I_D = 250\ \mu\text{Adc}$)	$V_{(BR)DSS}$	50	–	–	Vdc
Zero Gate Voltage Drain Current ($V_{DS} = 25\text{ Vdc}$, $V_{GS} = 0\text{ Vdc}$) ($V_{DS} = 50\text{ Vdc}$, $V_{GS} = 0\text{ Vdc}$)	I_{DSS}	–	–	0.1 0.5	μAdc
Gate-Source Leakage Current ($V_{GS} = \pm 20\text{ Vdc}$, $V_{DS} = 0\text{ Vdc}$)	I_{GSS}	–	–	± 0.1	μAdc

ON CHARACTERISTICS (Note 1.)

Gate-Source Threshold Voltage ($V_{DS} = V_{GS}$, $I_D = 1.0\text{ mAdc}$)	$V_{GS(th)}$	0.5	–	1.5	Vdc
Static Drain-to-Source On-Resistance ($V_{GS} = 2.75\text{ Vdc}$, $I_D < 200\text{ mAdc}$, $T_A = -40^\circ\text{C}$ to $+85^\circ\text{C}$) ($V_{GS} = 5.0\text{ Vdc}$, $I_D = 200\text{ mAdc}$)	$r_{DS(on)}$	–	5.6 –	10 3.5	Ohms

DYNAMIC CHARACTERISTICS

Input Capacitance	($V_{DS} = 25\text{ Vdc}$, $V_{GS} = 0$, $f = 1\text{ MHz}$)	C_{iss}	–	42	–	pF
Output Capacitance	($V_{DS} = 25\text{ Vdc}$, $V_{GS} = 0$, $f = 1\text{ MHz}$)	C_{oss}	–	15	–	
Transfer Capacitance	($V_{DG} = 25\text{ Vdc}$, $V_{GS} = 0$, $f = 1\text{ MHz}$)	C_{rss}	–	3	–	

SWITCHING CHARACTERISTICS (Note 2.)

Turn-On Delay Time	($V_{DD} = 30\text{ Vdc}$, $I_D = 0.2\text{ Adc}$,)	$t_{d(on)}$	–	5	–	ns
Turn-Off Delay Time		$t_{d(off)}$	–	7	–	

1. Pulse Test: Pulse Width $\leq 300\ \mu\text{s}$, Duty Cycle $\leq 2\%$.
2. Switching characteristics are independent of operating junction temperature.

LBSS8402DW1T1G , S-LBSS8402DW1T1G
P-Channel
ELECTRICAL CHARACTERISTICS ($T_A = 25^\circ\text{C}$ unless otherwise noted)

Characteristic	Symbol	Min	Typ	Max	Unit
----------------	--------	-----	-----	-----	------

OFF CHARACTERISTICS

Drain-to-Source Breakdown Voltage ($V_{GS} = 0\text{ Vdc}$, $I_D = 250\ \mu\text{Adc}$)	$V_{(BR)DSS}$	50	–	–	Vdc
Zero Gate Voltage Drain Current ($V_{DS} = 25\text{ Vdc}$, $V_{GS} = 0\text{ Vdc}$) ($V_{DS} = 50\text{ Vdc}$, $V_{GS} = 0\text{ Vdc}$) ($V_{DS} = 50\text{ Vdc}$, $V_{GS} = 0\text{ Vdc}$, $T_J = 125^\circ\text{C}$)	I_{DSS}	–	–	0.1 15 60	μAdc
Gate-Body Leakage Current ($V_{GS} = \pm 20\text{ Vdc}$, $V_{DS} = 0\text{ Vdc}$)	I_{GSS}	–	–	± 100	nAdc

ON CHARACTERISTICS (Note 1.)

Gate-Source Threshold Voltage ($V_{DS} = V_{GS}$, $I_D = 250\ \mu\text{Adc}$)	$V_{GS(th)}$	0.8	–	2.0	Vdc
Static Drain-to-Source On-Resistance ($V_{GS} = 5.0\text{ Vdc}$, $I_D = 100\text{ mAdc}$)	$r_{DS(on)}$	–	5.0	10	Ohms

DYNAMIC CHARACTERISTICS

Input Capacitance	($V_{DS} = 5.0\text{ Vdc}$)	C_{iss}	–	30	–	pF
Output Capacitance	($V_{DS} = 5.0\text{ Vdc}$)	C_{oss}	–	10	–	
Transfer Capacitance	($V_{DG} = 5.0\text{ Vdc}$)	C_{rss}	–	5.0	–	

SWITCHING CHARACTERISTICS (Note 2.)

Turn-On Delay Time	$(V_{DD} = -15\text{ Vdc}$, $I_D = -2.5\text{ Adc}$, $R_L = 50\ \Omega)$	$t_{d(on)}$	–	13	–	ns
Rise Time		t_r	–	6	–	
Turn-Off Delay Time		$t_{d(off)}$	–	16	–	
Fall Time		t_f	–	3	–	
Gate Charge		Q_T	–	6000	–	pC

1. Pulse Test: Pulse Width 300 μs , Duty Cycle 2%.
2. Switching characteristics are independent of operating junction temperature.

LBSS8402DW1T1G , S-LBSS8402DW1T1G

N-Channel TYPICAL ELECTRICAL CHARACTERISTICS

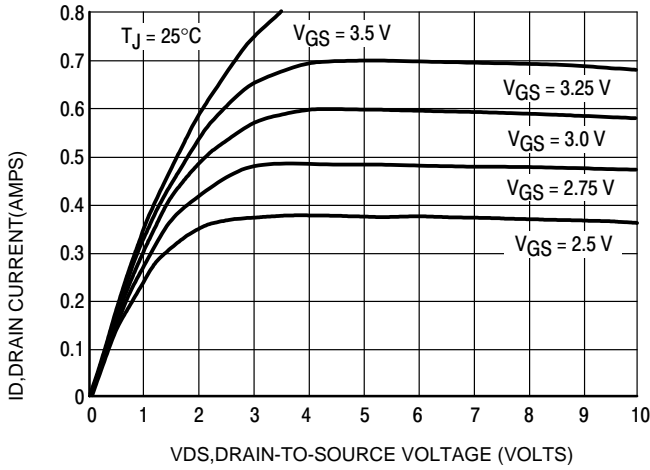

Figure 1. On-Region Characteristics

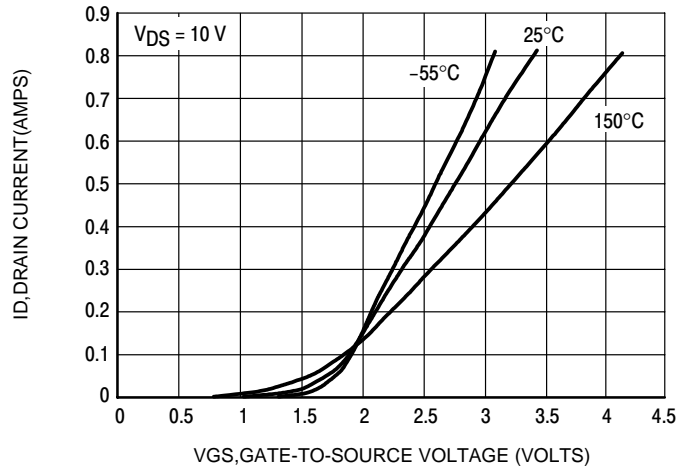

Figure 2. Transfer Characteristics

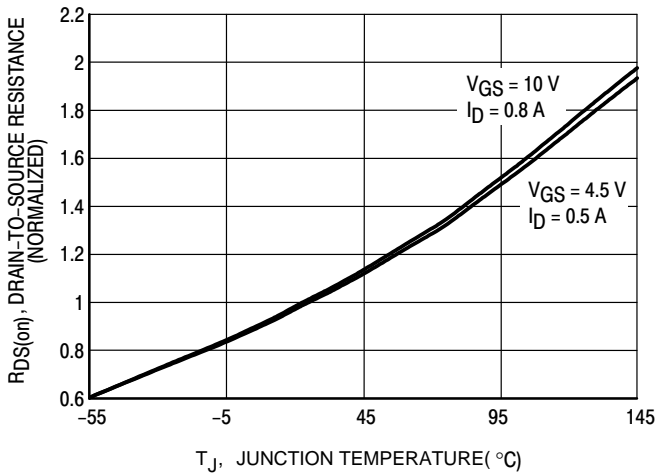

Figure 3. On-Resistance Variation with Temperature

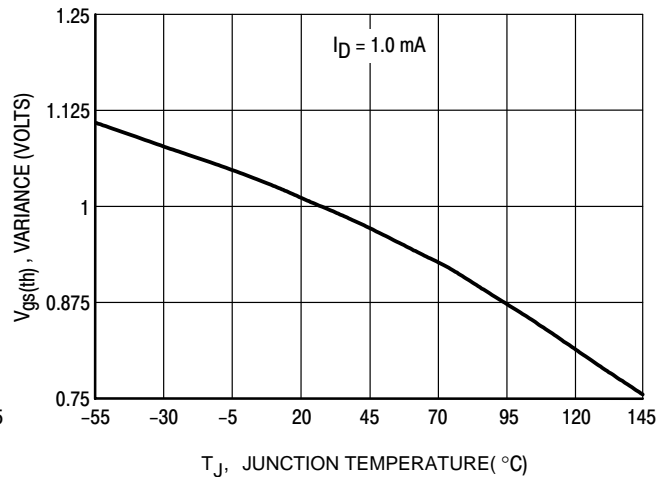

Figure 4. Threshold Voltage Variation with Temperature

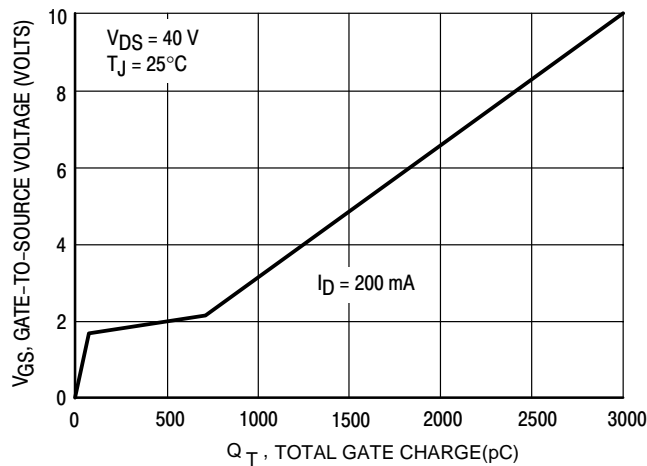

Figure 5. Gate Charge

LBSS8402DW1T1G , S-LBSS8402DW1T1G

P-Channel TYPICAL ELECTRICAL CHARACTERISTICS

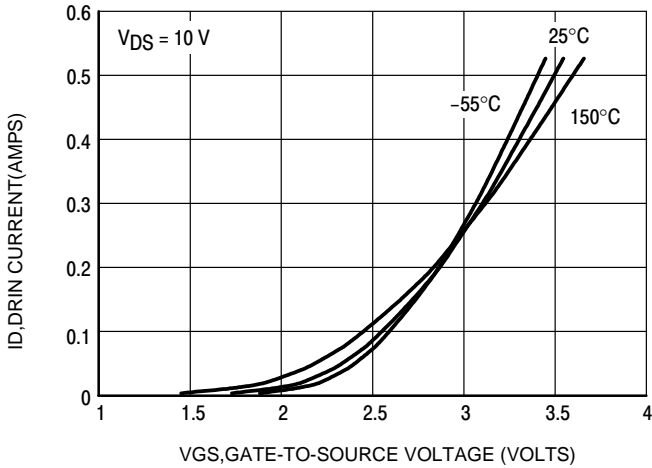

Figure 1. Transfer Characteristics

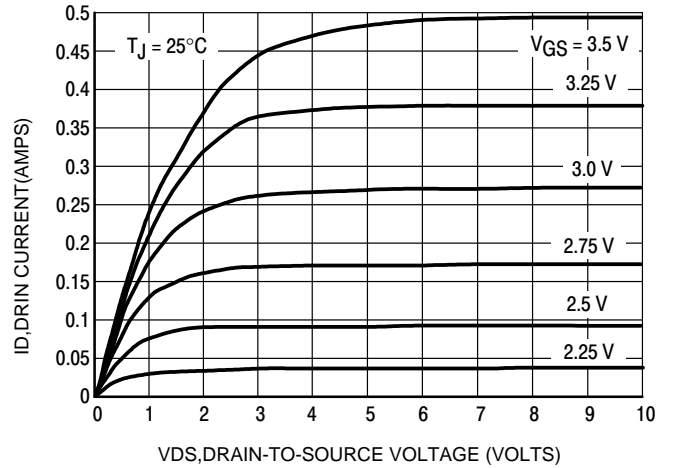

Figure 2. On-Region Characteristics

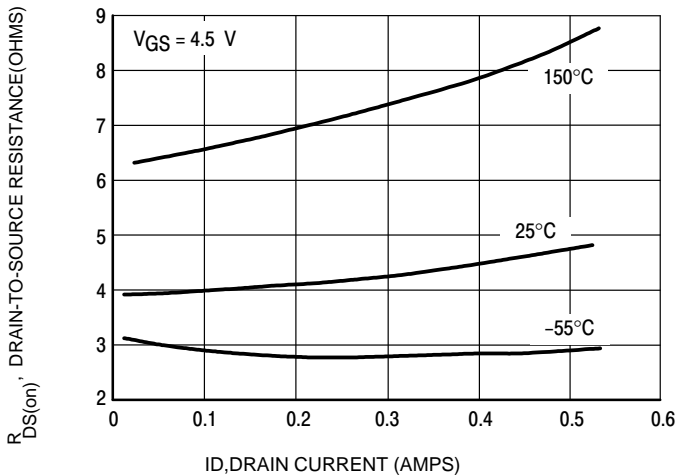

Figure 3. On-Resistance versus Drain Current

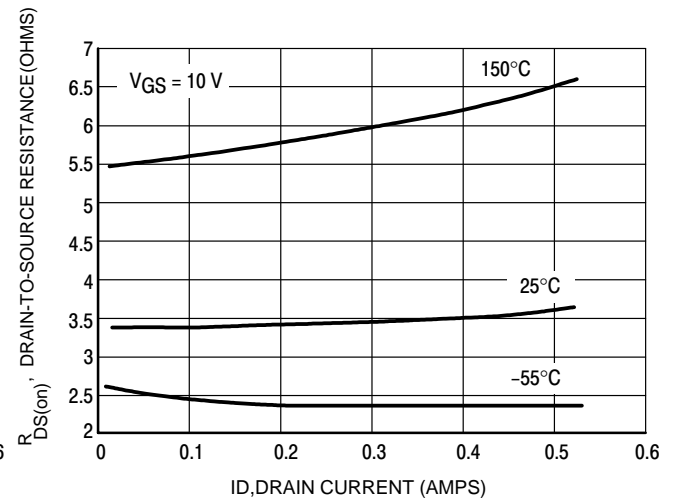

Figure 4. On-Resistance versus Drain Current

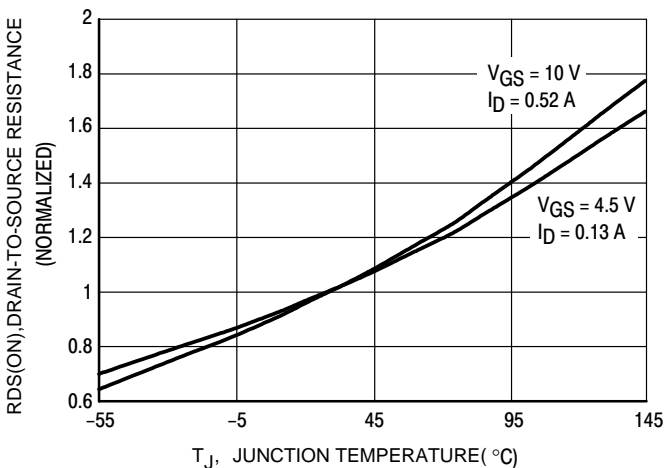

Figure 5. On-Resistance Variation with Temperature

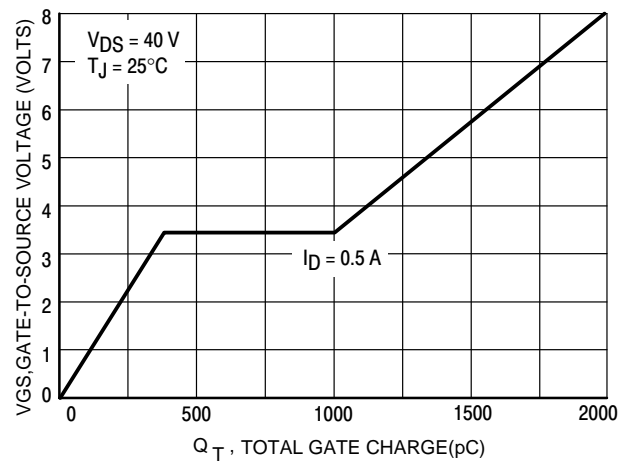
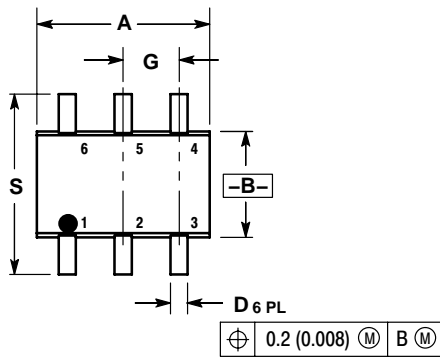

Figure 6. Gate Charge

LBSS8402DW1T1G , S-LBSS8402DW1T1G

SC-88 (SOT-363)
CASE 419B-02
ISSUE T



- NOTES:
1. DIMENSIONING AND TOLERANCING PER ANSI Y14.5M, 1982.
2. CONTROLLING DIMENSION: INCH.
3. 419B-01 OBSOLETE, NEW STANDARD 419B-02.

DIM	INCHES		MILLIMETERS	
	MIN	MAX	MIN	MAX
A	0.071	0.087	1.80	2.20
B	0.045	0.053	1.15	1.35
C	0.031	0.043	0.80	1.10
D	0.004	0.012	0.10	0.30
G	0.026	BSC	0.65	BSC
H	---	0.004	---	0.10
J	0.004	0.010	0.10	0.25
K	0.004	0.012	0.10	0.30
N	0.008	REF	0.20	REF
S	0.079	0.087	2.00	2.20

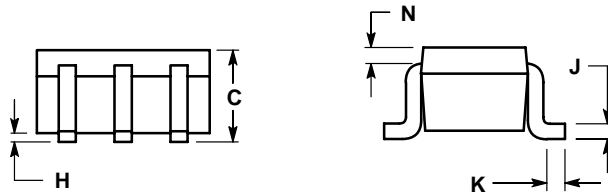

- STYLE 1:
PIN 1. EMITTER 2
2. BASE 2
3. COLLECTOR 1
4. EMITTER 1
5. BASE 1
6. COLLECTOR 2

SOLDERING FOOTPRINT*

