

LDN8205T1G

S-LDN8205T1G

N-Channel Enhancement Mode Power MOSFET

1. FEATURES

- $V_{DS} = 20V, I_D = 6A$
- $R_{DS(ON)}, V_{GS}@4.5V, I_{DS}@4.5A = 20m\Omega$
- $R_{DS(ON)}, V_{GS}@2.5V, I_{DS}@3.5A = 25m\Omega$
- We declare that the material of product compliance with RoHS requirements and Halogen Free.
- S- prefix for automotive and other applications requiring unique site and control change requirements; AEC-Q101 qualified and PPAP capable.
- High power and current handling capability
- Lead free product is acquired
- Surface mount package

2. APPLICATIONS

- Battery protection
- Load switch
- Power management

3. DEVICE MARKING AND ORDERING INFORMATION

Device	Marking	Shipping
LDN8205T1G	205	3000/Tape&Reel
LDN8205T3G	205	10000/Tape&Reel

4. Absolute Maximum Ratings (TA =25 °C unless otherwise noted)

Parameter	Symbol	Limits	Unit
Drain–Source Voltage	V_{DS}	20	V
Gate–Source Voltage	V_{GS}	± 12	V
Drain Current-Continuous	I_D	6	A
Drain Current-Pulsed (Note1)	I_{DM}	25	A
Maximum Power Dissipation	P_D	1.5	W
Operating Junction and Storage Temperature Range	T_J, T_{STG}	-55 ~ +150	°C

Note:1. Repetitive Rating: Pulse width limited by maximum junction temperature.

5. THERMAL CHARACTERISTICS

Parameter	Symbol	Limits	Unit
Thermal Resistance, Junction-to-Ambient (Note 2)	$R_{\theta JA}$	83	°C/W

Note:2. Surface Mounted on FR4 Board, $t \leq 10$ sec.

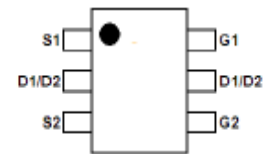
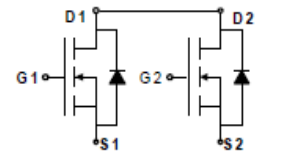
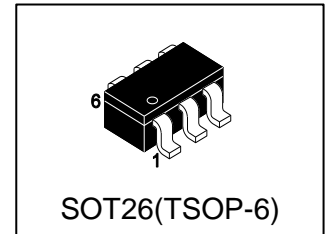

6. ELECTRICAL CHARACTERISTICS (Ta= 25°C)

Parameter	Symbol	Min.	Typ.	Max.	Unit
Off Characteristics					
Drain-Source Breakdown Voltage (VGS =0V ID =250μA)	BVDSS	20	-	-	V
Zero Gate Voltage Drain Current (VDS =20V, VGS =0V)	IDSS	-	-	1	μA
Gate-Body Leakage Current (VGS =±12V, VDS =0V)	IGSS	-	-	±100	nA
On Characteristics (Note 3)					
Gate Threshold Voltage (VDS =V GS ,ID =250μA)	VGS(th)	0.5	0.7	1.2	V
Drain-Source On-State Resistance (VGS =4.5V, ID =4.5A)	RDS(ON)	-	16	22	mΩ
(VGS =2.5V, ID =3.5A)		-	19	27	mΩ
(VGS =4.5 V, ID =6A)		-	-	25	mΩ
(VGS =2.5V, ID =5A)		-	-	32	mΩ
(VGS =1.8V, ID =1A)		-	-	47	mΩ
Forward Transconductance (VDS =5V, ID =4.5A)	gFS	-	10	-	S
Dynamic Characteristics (Note4)					
Input Capacitance (VDS =10V, VGS =0V, F=1.0MHz)	Ciss	-	900	-	PF
Output Capacitance (VDS =10V, VGS =0V, F=1.0MHz)	Coss	-	220	-	PF
Reverse Transfer Capacitance (VDS =10V, VGS =0V, F=1.0MHz)	Crss	-	100	-	PF
Switching Characteristics (Note 4)					
Turn-on Delay Time (VDD =10V, ID =1A VGS =4.5V, RGEN =6Ω)	td(on)	-	10	20	nS
Turn-on Rise Time (VDD =10V, ID =1A VGS =4.5V, RGEN =6Ω)	tr	-	11	25	nS
Turn-Off Delay Time (VDD =10V, ID =1A VGS =4.5V, RGEN =6Ω)	td(off)	-	35	70	nS
Turn-Off Fall Time (VDD =10V, ID =1A VGS =4.5V, RGEN =6Ω)	tf	-	30	60	nS
Total Gate Charge (VDS =10V, ID =6A, VGS =4.5V)	Qg	-	12	15	nC
Gate-Source Charge (VDS =10V, ID =6A, VGS =4.5V)	Qgs	-	2.3	-	nC
Gate-Drain Charge (VDS =10V, ID =6A, VGS =4.5V)	Qgd	-	1	-	nC
Drain-Source Diode Characteristics					
Turn-On Delay Time (VGS =0V, IS =1.0A)	VSD	-	0.75	1.5	V
Diode Forward Current (Note2)	IS	-	-	1.0	A

Note: 3. Pulse Test: Pulse Width ≤ 300μs, Duty Cycle ≤ 2%.

4. Guaranteed by design, not subject to production

7. ELECTRICAL CHARACTERISTICS CURVES

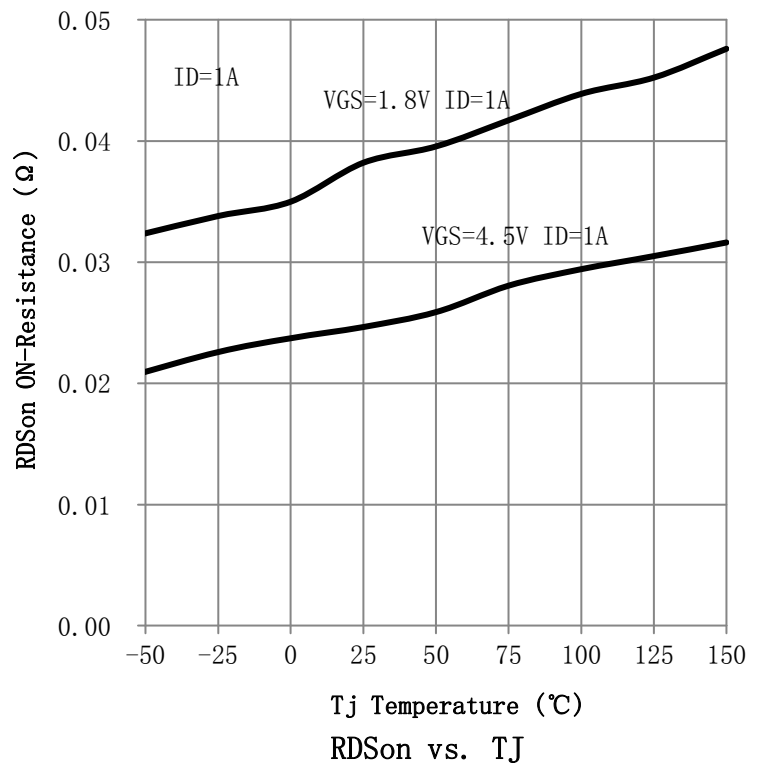
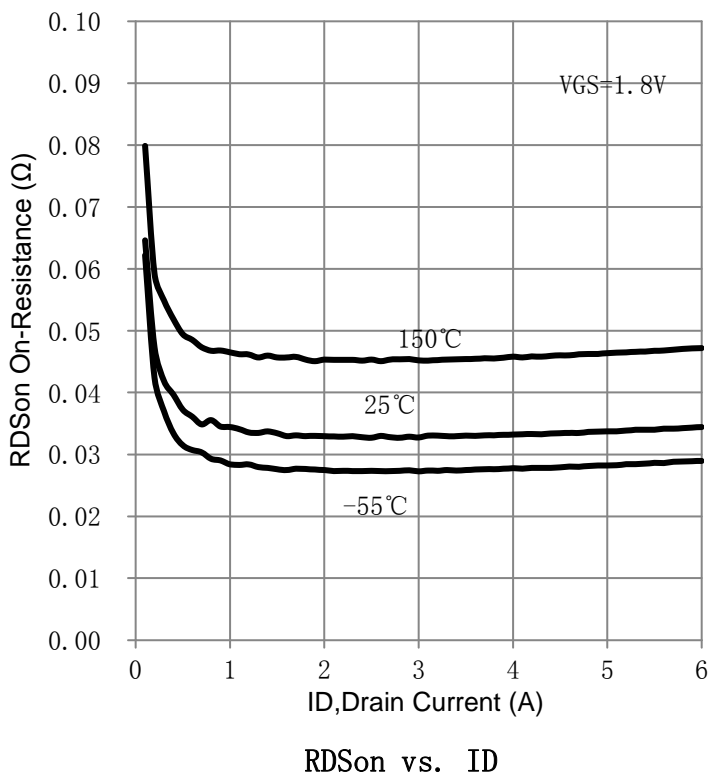
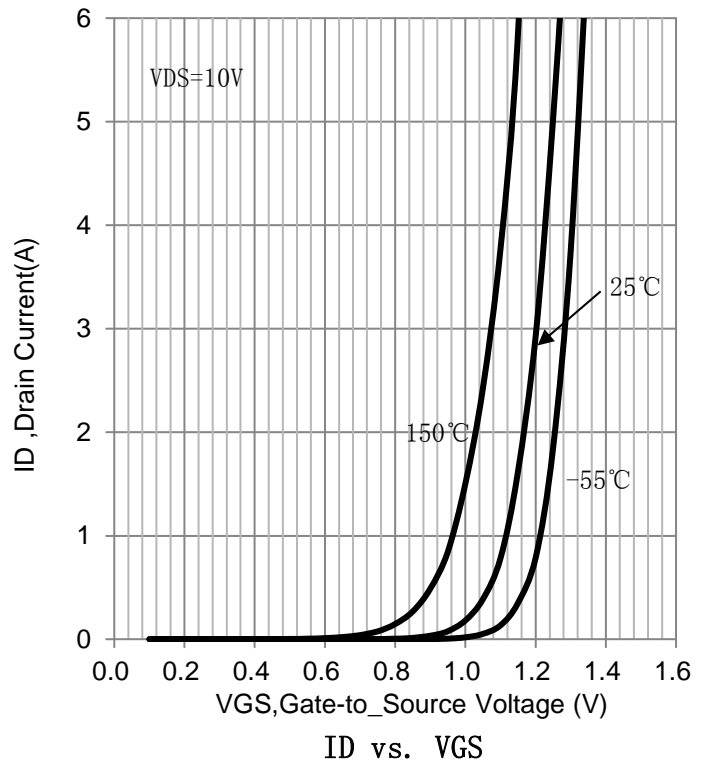
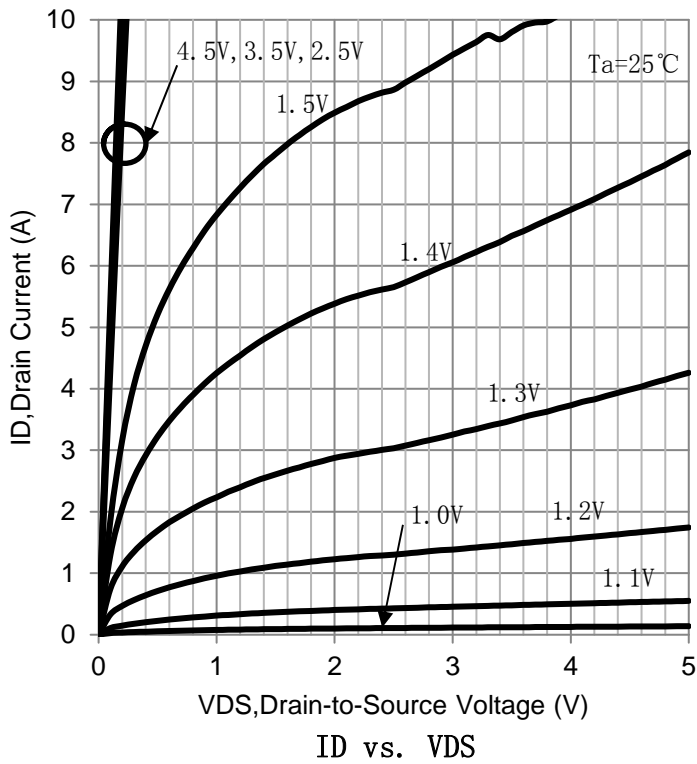

7.ELECTRICAL CHARACTERISTICS CURVES (Con.)

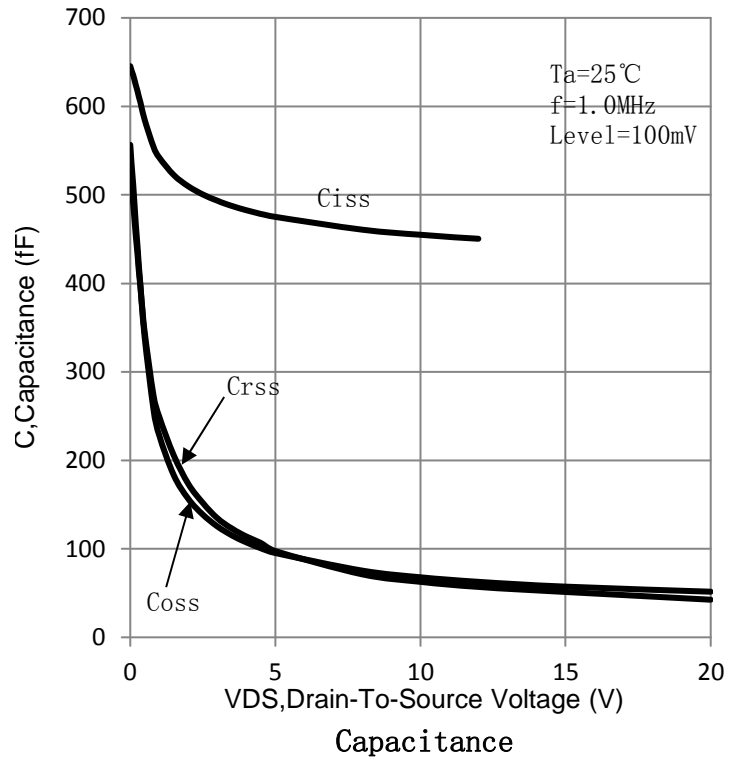
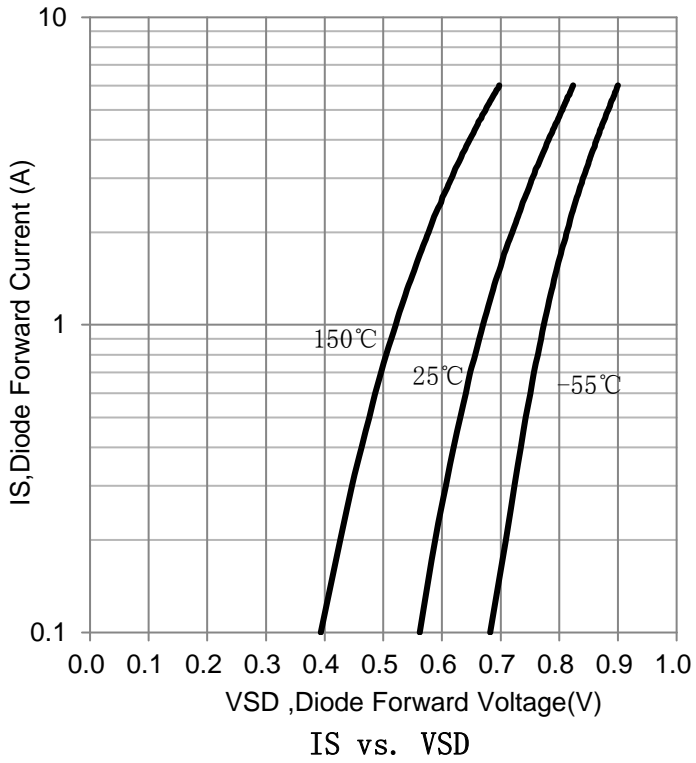

8. OUTLINE AND DIMENSIONS

Notes:

1. DIMENSIONING AND TOLERANCING PER ANSI Y14.5M, 1982.
2. CONTROLLING DIMENSION: MILLIMETERS.
3. MAXIMUM LEAD THICKNESS INCLUDES LEAD FINISH. MINIMUM LEAD THICKNESS IS THE MINIMUM THICKNESS OF BASE MATERIAL.
4. DIMENSIONS D AND E DO NOT INCLUDE MOLD FLASH, PROTRUSIONS OR GATE BURRS.

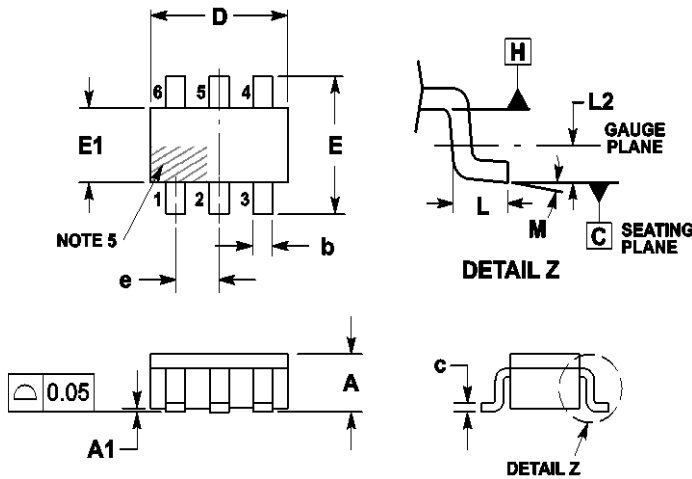

DIM	MILLIMETERS			INCHES		
	MIN	NOM	MAX	MIN	NOM	MAX
A	0.90	1.00	1.10	0.035	0.039	0.043
A1	0.01	0.06	0.10	0.0004	0.002	0.004
b	0.25	0.38	0.50	0.010	0.015	0.020
c	0.10	0.18	0.26	0.004	0.007	0.010
D	2.90	3.00	3.10	0.114	0.118	0.122
E	2.50	2.75	3.00	0.098	0.108	0.118
E1	1.30	1.50	1.70	0.051	0.059	0.067
e	0.85	0.95	1.05	0.033	0.037	0.041
L	0.20	0.40	0.60	0.008	0.016	0.024
L2	0.25REF			0.010REF		
M	0°	---	10°	0°	---	10°

9. SOLDERING FOOTPRINT

